

MODEL 3225 (1998)

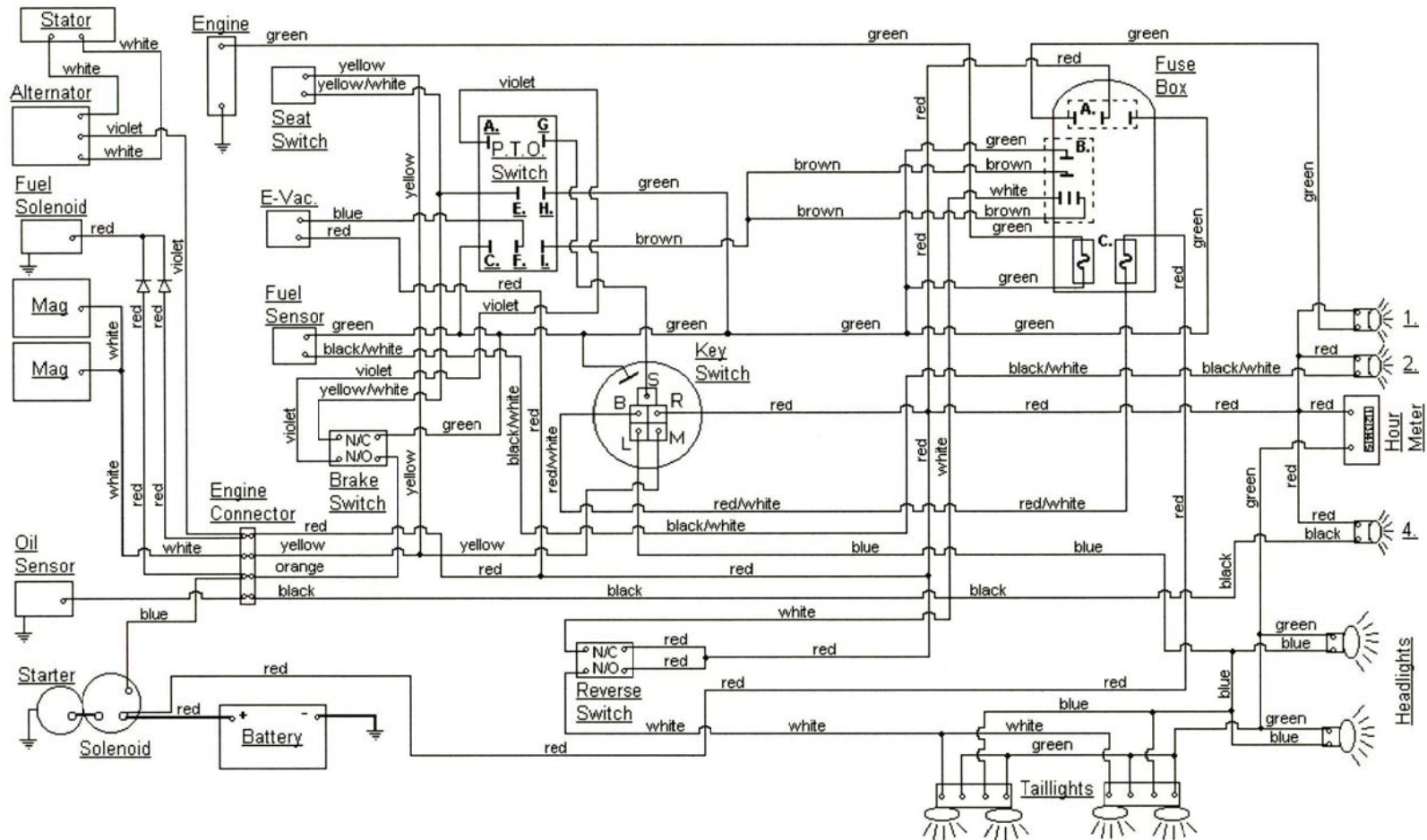

KEY SWITCH	
OFF	M+G
RUN w/LIGHTS	B+L+R
RUN	B+R
START	B+S

DASH LIGHTS	
1:	LOW VOLTAGE
2:	LOW FUEL
4:	LOW OIL

FUSE BOX	
A:	VOLTAGE SENSOR
B:	RELAY
C:	FUSES